



**A variety in look
for every window.**

The manifold variations of our vertical blind system with extremely comfortable operation modes allow the application of sundrape® vertical blinds for nearly all kinds of window types, at home, in your wintergarden, but also in office areas. Our system fits for rectangular, sloped, or curved windows as well as for ceiling windows, bay windows or oriel windows – there is no window shape that could not be well dressed with a sundrape® vertical blind system!

VERTICAL BLINDS

- Mounting Various fixing elements as clips, rail supports or adjustable mounting angles are at your disposal. By means of a mounting profile, you may hide the rail flush with the ceiling.
- Operation chain and cord drive (standard) or an easy operation with only one operation element (chain or crank), as well as comfortable, electric drive systems with remote control
- Size of profiles from 40 x 25 mm up to 46 x 36,5 mm
- Colour of profiles white colour (RAL 9016) coated or aluminium painted anodized
- Maximum measurements . rail width up to 7000 mm
- Slat sizes 63, 80, 90, 100, 127 or 160 mm

Subject to technical modifications • 01.2009 • 999.85E

Sundrape GmbH
 Im Wiebusch 4-6
 D-27607 Langen-Sievern
 fon: +49 (0) 4743.894-0
 fax: +49 (0) 4743.894-300
 Email: info@sundrape.com
 www.sundrape.com

Your sundrape® dealer:



VERTICAL BLINDS

VERTICAL BLINDS

sundrapé® offers more

sundrapé® vertical blind systems offer a large variety of solutions which fulfil every requirement. Current first class standard in its technique and elegantly shaped, sundrapé® vertical blinds care for an optimized and impressive light control in your rooms.

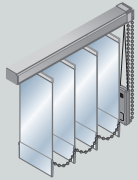

Star Zug

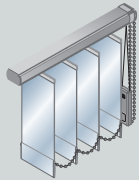

Star Softline

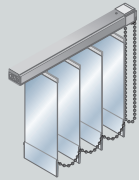

Star Mono

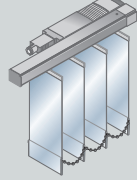

Star Elektro

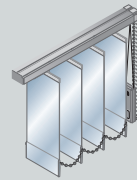

Future

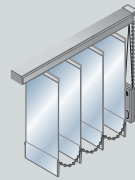

Palma

Quality and comfortable operation

With sundrapé® vertical blinds, you have made the right decision: An optimized operation comfort as well as long lasting and high-grade quality standard. Whether you choose a system with a 230 Volt electric drive and remote control or a system with manual operation - sundrapé® vertical blinds allow a continuous light regulation.



The ambience for every taste

There are no limits for your creative ideas with the complete range of technique and our extensive collection of slat fabrics. sundrapé® vertical blinds are an indispensable means for the design of your windows. Whether you use it as sun protection, sight protection or as a decorative element for your interior ambience – it is at any time an experience.



Future

stands for the ideal system for private and office areas with its very thin runners which enable small stacks.

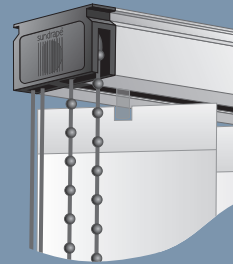

Star Zug Softline

This elegant and rounded variation of the well known classic model gives the rail a very decorative appearance.

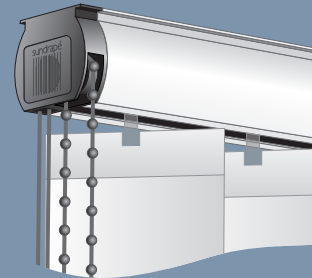

Star Mono

The operation process of moving and tilting is done, as described with its name "Mono" – with only one endless operation chain. A well thought – out mechanism!

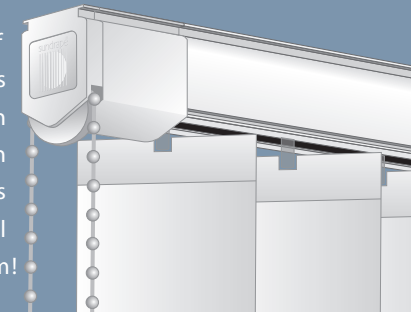

Slope



Plafond

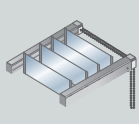

Corvus

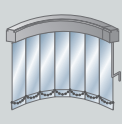

blind shapes

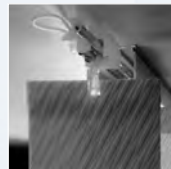

Future



Elektro

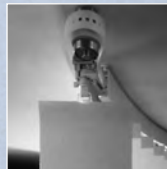

Corvus